

AVELLANADORES

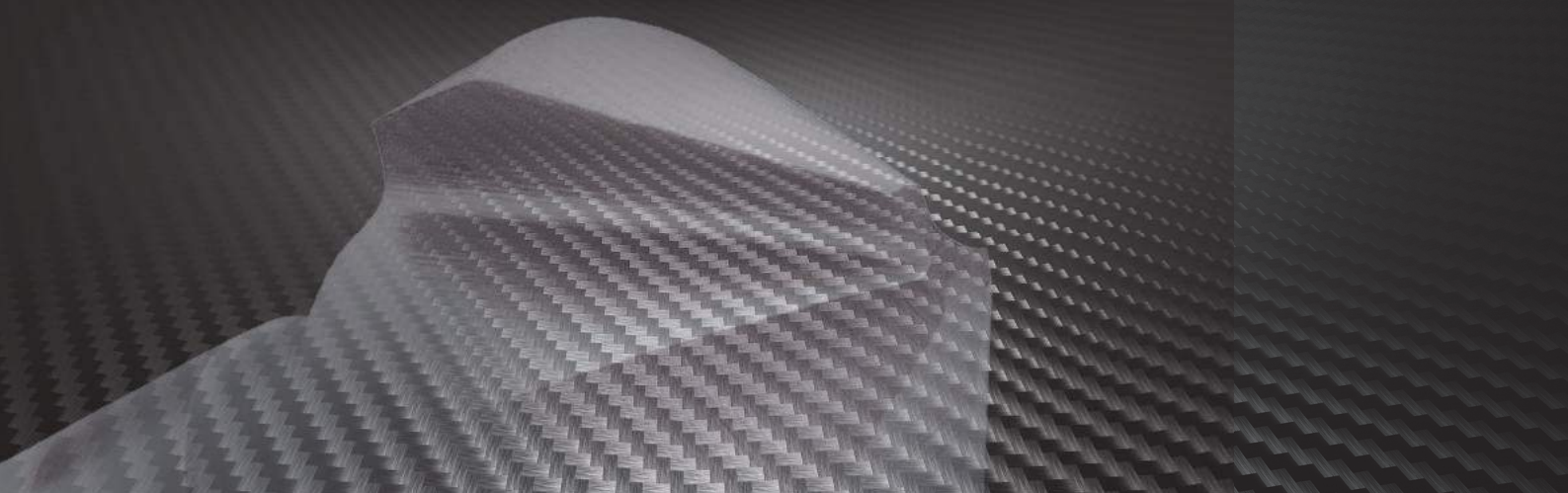

BROCAS AVELLANADORAS PARA TUBO Y CHAPA HSS Y HSSCo
HSS

Ref. AV30

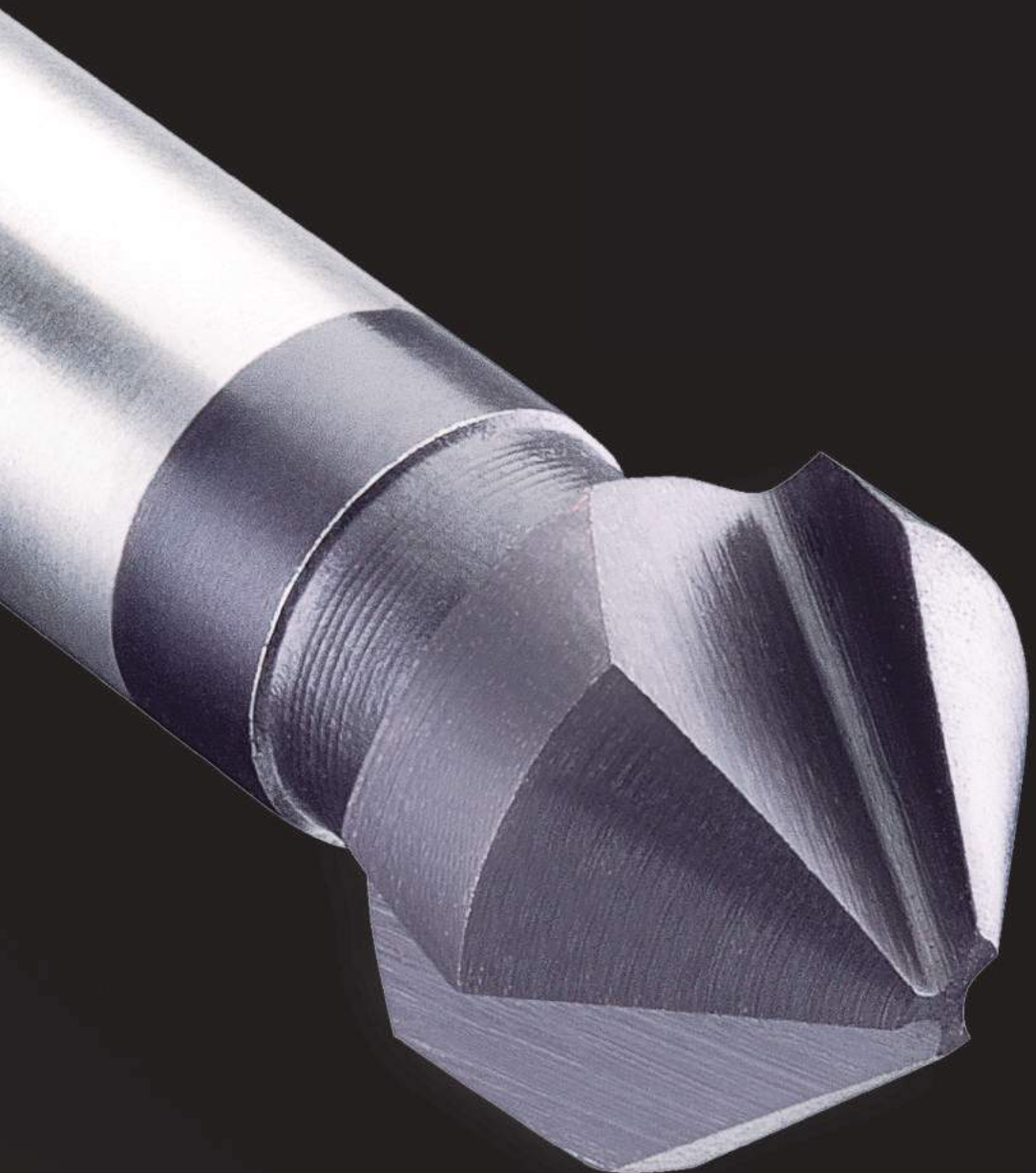
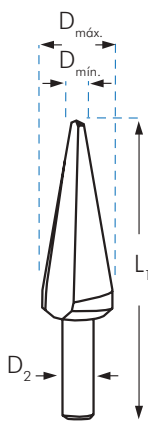

					AV30	
	D mín. mm	D máx. mm	D ₂ mm	L ₁ mm	HSS €	TiN €
AV30BM0B	3,0	14,0	6,0	58	16,25	34,07
AV30BM8B	3,0	22,5	8,0	85	44,95	85,41
AV30BM5B	3,0	31,0	10,0	102	71,88	112,95
AV30BM9B	5,0	25,4	10,0	87	51,11	102,38
AV30BM1B	6,0	20,0	8,0	63	22,94	48,79
AV30BM2B	16,0	30,0	10,0	79	44,37	82,27
AV30BM3B	26,0	40,0	13,0	86	91,80	150,73
AV30BM4	36,0	50,0	13,0	89	135,20	218,69
AV30BM6	40,0	61,0	13,0	98	223,99	365,75

* Las referencias acabadas en B, se suministran en blíster.

HSSCo

Ref. AVC30

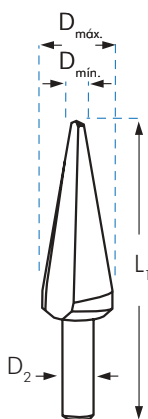

					AVC30	
	D mín. mm	D máx. mm	D ₂ mm	L ₁ mm	HSSCo €	TiN €
AVC30BM0B	3,0	14,0	6,0	58	30,09	41,21
AVC30BM1B	6,0	20,0	8,0	63	39,90	63,54
AVC30BM2B	16,0	30,0	10,0	79	65,84	92,04
AVC30BM3B	26,0	40,0	13,0	86	171,30	193,84

BROCAS AVELLANADORAS PARA CHAPA HSS CARACTERISTICAS ESPECIALES

HSS

CANAL HELICOIDAL

	D mín. mm	D máx. mm	D ₂ mm	L ₁ mm	AV36	
					HSS	TiN
					€	€
AV36BM0B	3,0	14,0	6,0	60	26,24	44,07
AV36BM1B	5,0	20,0	8,0	76	34,29	59,00
AV36BM2B	5,0	31,0	10,0	105	70,31	108,22



Ref. AV36

3 CORTES

	D mín. mm	D máx. mm	D ₂ mm	L ₁ mm	AV33	
					HSS	TiN
					€	€
AV33BM0B	3,0	14,0	6,0	58	40,47	55,55
AV33BM1B	5,0	20,0	8,0	71	48,55	67,50
AV33BM2B	16,0	30,5	9,0	76	84,75	115,82



Ref. AV33

MANGO HEXAGONAL 1/4"

	D mín. mm	D máx. mm		L ₁ mm	AV32	
					HSS	TiN
					€	€
AV32BM1B	5,0	20,0	1/4"	78	40,57	65,92



Ref. AV32

TOPE DE PROFUNDIDAD

	D mín. mm	D máx. mm	D ₂ mm	L ₁ mm	AV31	
					HSS	TiN
					€	€
AV31BM0B	3,0	7,8	6,0	48	26,06	41,35
AV31BM1B	3,0	10,2	6,0	52	34,21	56,25
AV31BM2B	3,0	11,8	6,0	56	38,08	70,55



Ref. AV31

BROCAS ESCALONADAS DE CANALES RECTOS HSS
HSS

Ref. AV40

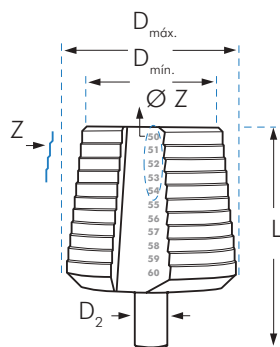
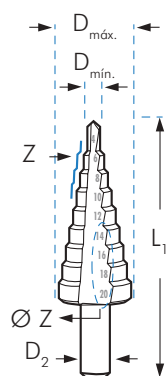

Ref. AV40BM25 / 26 / 27 / 28 / 29

	D mín. mm	D máx. mm	D ₂ mm	L ₁ mm	Z	Ø Z mm menor-mayor	AV40	
							HSS €	TiN €
AV40BM1B	4,0	12,0	6,0	56	5	4-6-8-10-12	33,56	53,40
AV40BM2B	4,0	12,0	6,0	65	9	4-5-6-7-8-9-10-11-12	33,42	53,71
AV40BM3B	4,0	20,0	8,0	69	9	4-6-8-10-12-14-16-18-20	42,84	68,56
AV40BM4B	4,0	30,0	10,0	96	14	4-6-8-10-12-14-16-18-20-22-24-26-28-30	83,89	130,27
AV40BM14	4,0	39,0	10,0	107	13	4-6-9-12-15-18-21-24-27-30-33-36-39	172,77	279,74
AV40BM16B	5,0	28,0	10,0	69	7	5-8,8-11,8-15,3-19-24,5-28	80,14	132,24
AV40BM11B	6,0	25,0	10,0	65	7	6-9-12-16-20-22,50-25	65,44	98,26
AV40BM10B	6,0	26,7	10,0	75	8	6-9-11,40-14-17,25-19-21,25-26,75	127,42	210,24
AV40BM17B	6,0	30,5	10,0	80	9	6-9-12,5-15,2-18,6-20,4-22,5-28,3-30,5	135,28	223,21
AV40BM12B	6,0	32,0	10,0	75	9	6-9-12-16-20-22,5-25-28,5-32	92,36	132,40
AV40BM18B	6,0	37,0	10,0	100	12	6-9-12,5-15,2-18,6-20,4-22,5-26-28,3-30,5-34-37	151,79	244,35
AV40BM5B	6,0	38,0	10,0	96	12	6-9-13-16-19-21-23-26-29-32-35-38	183,13	243,18
AV40BM13	6,0	40,0	13,0	105	16	6-11-17-23-29-30-31-32-33-34-35-36-37-38-39-40	223,69	288,19
AV40BM15B	6,5	32,5	10,0	79	9	6,50-8,50-10,50-12,50-16,50-20,50-25,50-29-32,50	106,94	157,14
AV40BM20	6,5	40,5	10,0	96	11	6,50-8,50-10,50-12,50-16,50-20,50-25,50-29-32,50-36,50-40,50	167,65	276,64
AV40BM21B	7,0+10,0	20,0	10,0	80	12	7-10-11-12-13-14-15-16-17-18-19-20	67,08	110,68
AV40BM22B	10,0+20,0	30,0	13,0	83	12	10-20-21-22-23-24-25-26-27-28-29-30	105,00	172,73
AV40BM25B	12,0	20,0	8,0	66	9	12-13-14-15-16-17-18-19-20	62,20	87,28
AV40BM26B	20,0	30,0	10,0	78	11	20-21-22-23-24-25-26-27-28-29-30	90,73	134,01
AV40BM27	30,0	40,0	10,0	78	11	30-31-32-33-34-35-36-37-38-39-40	142,49	192,35
AV40BM28	40,0	50,0	13,0	85	11	40-41-42-43-44-45-46-47-48-49-50	220,85	322,75
AV40BM29	50,0	60,0	13,0	85	11	50-51-52-53-54-55-56-57-58-59-60	330,44	430,39

PARA PASAR TUBERÍAS ROSCA GAS

AV40BM6B	6,0	32,0	10,0	75	8	6-9-11,20(1/8)-14,50(1/4)-18,20(3/8)-22,30(1/2)-27,90(3/4)-32	95,83	137,73
----------	-----	------	------	----	---	---	-------	--------

PARA REMACHES CIEGOS M3 - M4 - M5 - M6 Y M7

AV40BM7B	4,8	10,6	6,0	54	5	4,80-6,40-7,20-9,60-10,65	31,23	46,71
----------	-----	------	-----	----	---	---------------------------	-------	-------

PARA CONDUCCIONES ELÉCTRICAS (ANTIGUA Y NUEVA NORMA)

AV40PG21B	PG7	PG21	13,0	70	6	PG7-PG9-PG11-PG13,50-PG16-PG21	105,52	156,42
AV40PG29B	PG7	PG29	13,0	81	7	PG7-PG9-PG11-PG13,50-PG16-PG21-PG29	136,31	200,51
AV40BM8B	8,5+10,5	32,5	10,0	70	12	(8,5)-10,5-12,5-14,5-16,5-18,5-20,5-23,5-25,5-28-30,5-32,5	79,99	128,97
AV40BM9B	8,5+10,5	40,5	12,0	84	16	(8,5)-10,5-12,5-14,5-16,5-18,5-20,5-23,5-25,5-28-30,5-32,5-34,5-36,5-38,5-40,5	126,71	198,35

BROCAS ESCALONADAS DE CANALES RECTOS HSSCo

HSSCo

Ref. AVC40

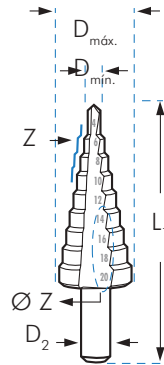

						AVC40		
	D mín. mm	D máx. mm	D ₂ mm	L ₁ mm	Z	Ø Z mm menor-mayor	HSSCo €	TiN €
AVC40BM1B	4,0	12,0	6,0	56	5	4-6-8-10-12	51,11	77,34
AVC40BM2B	4,0	12,0	6,0	65	9	4-5-6-7-8-9-10-11-12	53,97	93,40
AVC40BM3B	4,0	20,0	8,0	69	9	4-6-8-10-12-14-16-18-20	81,58	105,83
AVC40BM4B	4,0	30,0	10,0	96	14	4-6-8-10-12-14-16-18-20-22-24-26-28-30	117,34	165,90
AVC40BM18B	6,0	37,0	10,0	100	12	6-9-12,5-15,2-18,6-20,4-22,5-26-28,3-30,5-34-37	210,19	278,72

BROCAS ESCALONADAS DE CANALES HELICOIDALES HSS

HSS

Ref. AV42

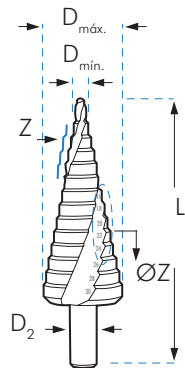

						AV42		
	D mín. mm	D máx. mm	D ₂ mm	L ₁ mm	Z	Ø Z mm menor-mayor	HSS €	TiN €
AV42BM1B	4,0	12,0	6,0	56	5	4-6-8-10-12	46,11	62,27
AV42BM2B	4,0	12,0	6,0	68	9	4-5-6-7-8-9-10-11-12	47,69	64,84
AV42BM3B	4,0	20,0	8,0	69	9	4-6-8-10-12-14-16-18-20	67,67	90,66
AV42BM4B	4,0	30,0	10,0	96	14	4-6-8-10-12-14-16-18-20-22-24-26-28-30	107,65	144,33
AV42BM5B	6,0	38,0	10,0	96	12	4-6-9-12-15-18-21-24-27-30-33-36-38	193,51	257,47
AV42BM11B	6,0	25,0	10,0	65	7	6-9-12-16-20-22,50-25	78,00	106,33
AV42BM12B	6,0	32,0	10,0	75	9	6-9-12-16-20-22,5-25-28,5-32	101,74	133,82
AV42BM13	6,0	40,0	13,0	105	16	6-11-17-23-29-30-31-32-33-34-35-36-37-38-39-40	224,57	304,01
AV42BM8B	8,5 + 10,5	32,5	10,0	70	12	(8,5)-10,5-12,5-14,5-16,5-18,5-20,5-23,5 25,5-28-30,5-32,5	102,68	139,15
AV42BM9B	8,5 + 10,5	40,5	12,0	84	16	(8,5)-10,5-12,5-14,5-16,5-18,5-20,5-23,5 25,5-28-30,5-32,5-34,5-36,5-38,5-40,5	161,47	205,93

BROCAS ESCALONADAS HSS CARACTERÍSTICAS ESPECIALES
HSS
MANGO HEXAGONAL 1/4"

	D mín. mm	D máx. mm		L1 mm	Z	Ø Z mm menor-mayor	AV41	
							HSS €	TiN €
AV41BM2B	4,0	12,0	1/4"	72	9	4-5-6-7-8-9-10-11-12	73,06	94,99
AV41BM3B	4,0	20,0	1/4"	81	9	4-6-8-10-12-14-16-18-20	96,59	125,61
AV41BM4B	4,0	30,0	1/4"	105	14	4-6-8-10-12-14-16-18-20-22-24-26-28-30	114,48	144,60



Ref. AV41BM2

SERIE CORTA Máximo 2 mm de espesor

	D mín. mm	D máx. mm	D2 mm	L1 mm	Z	Ø Z mm menor-mayor	AV41C	
							HSS €	TiN €
AV41CBM2B	4,0	12,0	6,0	48	9	4-5-6-7-8-9-10-11-12	51,98	73,17
AV41CBM3B	4,0	20,0	8,0	58	9	4-6-8-10-12-14-16-18-20	64,54	94,56
AV41CBM4B	4,0	30,0	10,0	72	14	4-6-8-10-12-14-16-18-20-22-24-26-28-30	105,22	169,88



Ref. AV41CBM3

ATORNILLAMIENTOS MÉTRICOS DE CABLE

	DIN	D mín. mm	D máx. mm	D2 mm	L1 mm	Z	Ø Z mm menor-mayor	AV45	
								HSS €	TiN €
AV45BM0B	60423	5,3	30,5	10,0	79	9	5,3-7-9-10,5-14,5-18,5-23,5-27-30,5	143,44	193,94
AV45BM1B	50262	6,5	32,5	10,0	79	9	6,5-8,5-10,5-12,5-16,5-20,5 25,5-29-32,5	145,88	201,29
AV45BM2B	60423	5,3	38,5	10,0	96	11	5,3-7-9-10,5-14,5-18,5-23,5-27 30,5-34,5-38,5	172,49	228,51
AV45BM3B	50262	6,5	40,5	10,0	96	11	6,5-8,5-10,5-12,5-16,5-20,5-25,5 29-32,5-36,5-40,5	174,12	228,97



Ref. AV45BM3

ESCALONADA RECTA CON 3 CORTES

	D mín. mm	D máx. mm	D2 mm	L1 mm	Z	Ø Z mm menor-mayor	AV43	
							HSS €	TiN €
AV43BM1B	4,0	12,0	6,0	65	9	4-5-6-7-8-9-10-11-12	62,66	85,97
AV43BM2B	4,0	20,0	8,0	75	9	4-6-8-10-12-14-16-18-20	85,91	139,57
AV43BM3B	4,0	30,0	10,0	100	14	4-6-8-10-12-14-16-18-20-22-24-26-28-30	126,30	216,60



Ref. AV43BM3

AVELLANADORES DE 3 CANALES

3Z

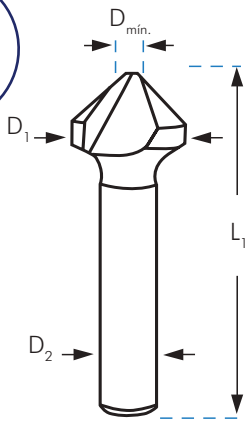

				AV6	AV7	AV16	AV37	AV38	AV19	AV6MD	AV15
MATERIAL				HSS	HSSCo	HSS	HSS	HSSCo	HSS	MD	HSS
NORMA				DIN 335C	DIN 335C	DIN 335C	DIN 335C	DIN 335C	DIN 335C	DIN 335C	DIN 335C
ÁNGULO DE PUNTA				90°	90°	90°	90°	90°	90°	90°	90°
ACABADO						TiN	TiAlN	TiAlSiN			
APLICACIÓN				USO GENERAL	USO GENERAL INOX	USO GENERAL	USO GENERAL	INOX Plus	AI	MATERIAL DURO	
D1 mm	D mín. mm	D2 mm	L1 mm	€	€	€	€	€	€	€	€
4,30	1,3	4,0	40	14,72	16,23	26,94	31,71	50,85			
5,00	1,5	4,0	40	14,72	16,23	26,94	31,71	50,85			
5,30	1,5	4,0	40	14,72	16,23	26,94	31,71	50,85		54,71	
5,80	1,5	5,0	45	11,18	13,20	23,67	29,76	44,51		55,97	
6,00	1,5	5,0	45	10,65	12,69	23,15	29,76	43,97			
6,30	1,5	5,0	45	10,46	12,45	23,15	29,76	43,73	17,24	61,12	
7,00	1,8	6,0	50	14,72	16,23	30,91	39,70	59,13			
7,30	1,8	6,0	50	14,72	16,23	30,91	39,70	59,13		65,23	
8,00	2,0	6,0	50	14,72	16,39	30,91	39,70	59,30			
8,30	2,0	6,0	50	14,50	16,09	30,91	39,70	58,97	19,30	69,43	
9,40	2,2	6,0	50	17,16	18,98	34,88	44,48	67,13		74,66	
10,00	2,5	6,0	50	17,16	18,98	34,88	44,48	67,13			
10,40	2,5	6,0	50	16,85	19,56	34,88	44,48	66,94	22,69	75,73 **	49,99
11,50	2,8	8,0	56	17,25	20,94	36,95	47,83	72,77			
12,40	2,8	8,0	56	16,96	20,70	36,95	47,83	72,50	24,83	78,97	61,54
13,40	2,9	8,0	56	18,65	22,58	38,17	49,40	76,22		85,27	
15,00	3,2	10,0	60	23,68	28,76	51,29	67,64	101,97			
16,50	3,2	10,0	60	23,28	28,37	52,67	67,64	101,52	29,65	86,48	74,16
19,00	3,5	10,0	63	34,87	42,54	64,26	82,08	132,23			
20,50	3,5	10,0	63	34,28	41,76	65,63	84,55	133,92	41,19	119,92	99,40
23,00	3,8	10,0	67	42,87	51,83	74,76	94,61	155,52			
25,00	3,8	10,0	67	43,25	52,76	75,82	95,60	157,59	58,12	195,68	119,89
28,00	4,0	12,0	71	60,40	75,34	96,38	123,70	211,79			
30,00	4,2	12,0	71	64,18	79,69	100,00	161,21	255,41			
31,00	4,2	12,0	71	66,82	79,69	103,65	173,11	267,72	79,56	220,80	140,44
40,00	6,5	13,0	80	99,35	116,63	158,19	203,54	334,12	125,63	383,36 *	

* Mango de 16 mm

** Mango de 8 mm

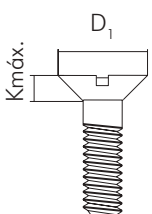

DIN 7991

DIMENSIONES TORNILLO CABEZA CÓNICA 90°

	M2	M2.5	M3	M4	M5	M6	M8	M10	M12	M14	M16	M18	M20
Kmáx.	1,2	1,5	1,7	2,3	2,8	3,3	4,4	5,5	6,5	7	7,5	8	8,5
D1	4	5	6	8	10	12	16	20	24	27	30	33	36

AVELLANADORES HSS MANGO CILÍNDRICO 60°, 75°, 120°
3Z

				AV8		AV9		AV10	
MATERIAL				HSS		HSS		HSS	
NORMA				DIN 334C		NORMA CELESA		NORMA CELESA	
ÁNGULO DE PUNTA				60°		75°		120°	
D ₁ mm	D _{mín} mm	D ₂ mm	L ₁ mm	€		€		€	
6,30	1,5	5,0	45	AV80630	16,38	AV90630	12,61	AV100630	13,42
8,00	2,0	6,0	50	AV80800	18,01				
8,30	2,0	6,0	50			AV90830	17,19	AV100830	18,49
10,00	2,5	6,0	50	AV81000	19,64				
10,40	2,5	6,0	50			AV91040	20,31	AV101040	21,61
12,40	2,8	8,0	56	AV81250	21,77	AV91240	22,43	AV101240	25,87
16,50	3,2	10,0	60	AV81600	27,85	AV91650	28,15	AV101650	32,74
20,50	3,5	10,0	63	AV82000	39,30	AV92050	41,43	AV102050	48,31
25,00	3,8	10,0	67	AV82500	54,85	AV92500	52,22	AV102500	60,92
40,00	6,5	13,0	80	AV84000	126,02	AV94000	113,62	AV104000	133,90

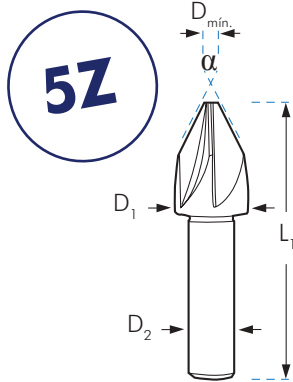
AVELLANADORES MULTICORTE MANGO CILÍNDRICO 60°, 90° Y 120°

				AV12		AV11		AV13				
MATERIAL				HSS		HSS		HSS				
DIN				DIN 334A		DIN 335A		DIN 347A				
ÁNGULO DE PUNTA				60°		90°		120°				
D ₁ mm	D _{mín} mm	D ₂ mm	N° Z	L ₁ mm	€	L ₁ mm	€	L ₁ mm	€			
8,00	2,5	8,0	5	AV120800	48	14,31	AV110800	44	10,56	AV130800	44	14,27
12,50	2,8	8,0	5	AV121250	52	20,03	AV111250	48	15,47	AV131250	48	20,94
16,00	3,0	10,0	5	AV121600	60	33,61	AV111600	56	25,98	AV131600	56	35,13
20,00	3,5	10,0	5	AV122000	64	43,35	AV112000	60	33,46	AV132000	60	45,30
25,00	3,5	12,0	5	AV122500	69	60,68	AV112500	65	46,84	AV132500	65	61,62

AVELLANADORES HSS Y HSSCo PARA DESBARBAR CON AGUJERO

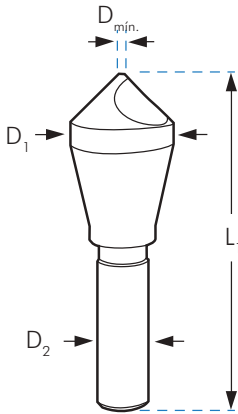

				AV1		AV1T		AV20		AV20T		AV1-60	
MATERIAL				HSS		HSS		HSSCo		HSSCo		HSS	
ACABADO						TiN				TiN			
ÁNGULO DE PUNTA				90°		90°		90°		90°		60°	
D1 mm	D mín mm	D2 mm	L1 mm		€		€		€		€		
6,35	1,0	6,35	45	AV100	11,68	AV100T	21,71	AV200	19,86	AV200T	34,36	AV100-60	20,93
10,00	2,0	6,00	45	AV101	14,40	AV101T	22,71	AV201	20,51	AV201T	34,36	AV101-60	26,15
14,00	5,0	8,00	48	AV102	18,00	AV102T	31,92	AV202	23,88	AV202T	42,84	AV102-60	31,74
20,00	10,0	10,00	65	AV103	32,22	AV103T	57,07	AV203	42,70	AV203T	72,51	AV103-60	36,21
27,00	15,0	12,00	85	AV104	57,58	AV104T	93,83	AV204	69,57	AV204T	114,23	AV104-60	63,08
30,00	20,0	15,00	95	AV105	97,18	AV105T	178,05	AV205	110,53	AV205T	196,29	AV105-60	103,37
35,00	25,0	15,00	100	AV106	149,26	AV106T	243,81	AV206	185,19	AV206T	330,10	AV106-60	163,82
40,00	30,0	15,00	110	AV107	206,08	AV107T	346,50	AV207	213,08	AV207T	353,67	AV107-60	222,02
45,00	35,0	15,00	120	AV108	273,05	AV108T	420,84	AV208	320,22	AV208T	469,18	AV108-60	286,94
55,00	40,0	15,00	130	AV109	329,45	AV109T	489,28	AV209	426,79	AV209T	589,05	AV109-60	349,62

AVELLANADORES EXTERNOS DE 3 CORTES

3Z

Ref. AVX

HSS



Ref. AVX-60

HSS

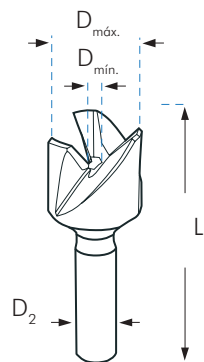
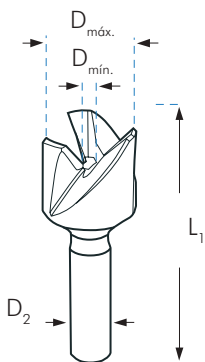

					AVX
D máx. mm	D mín. mm	D2 mm	L1 mm		€
12,00	4,0	8,0	55	AVX1	36,59
20,00	6,0	10,0	60	AVX2	63,47
28,00	8,0	13,0	70	AVX3	90,03
40,00	10,0	13,0	100	AVX4	188,67
50,00	15,0	13,0	100	AVX5	263,60

					AVX-60
D máx. mm	D mín. mm	D2 mm	L1 mm		€
8,00	3,0	8,0	55	AVX1-60	35,18
15,00	4,0	10,0	60	AVX2-60	69,84
28,00	10,0	13,0	80	AVX3-60	104,67

AVELLANADORES CON MANGO CÓNICO

3Z

Ref. AV17

DIN 335D

HSS



Ref. AV17MD

DIN 335D

MD

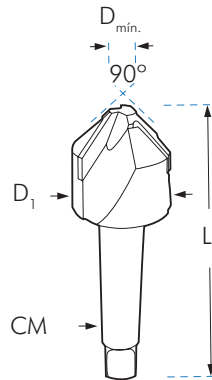
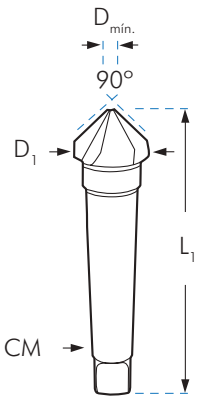
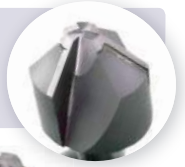

				AV17
D1 mm	D mín. mm	L1 mm	CM	€
16,50	4,0	90	1	67,98
20,50	3,5	100	2	80,91
25,00	3,8	106	2	81,74
31,00	4,2	112	2	90,99
40,00	10,0	140	3	138,70
50,00	14,0	150	3	174,59
63,00	16,0	180	4	282,29
80,00	22,0	190	4	483,00
100,00	25,0	210	4	1.256,69

				AV17MD
D1 mm	D mín. mm	L1 mm	CM	€
50,00	14,0	123	3	997,27
63,00	16,0	190	4	1.192,75
80,00	22,0	190	4	1.456,12

AVELLANADORES MULTICORTE CON MANGO CÓNICO

MULTI CORTE

Ref. AV23

DIN 334B



Ref. AV18

DIN 335B



Ref. AV24

DIN 347B

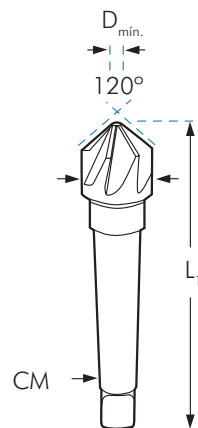
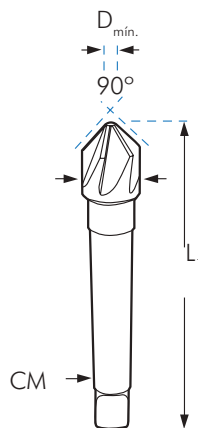
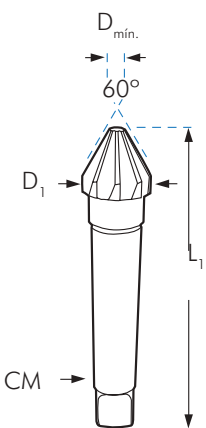
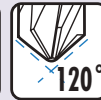

					AV23
D1 mm	D mín. mm	L1 mm	CM	Z	HSS €
16,00	3,2	93	1	7	52,07
20,00	4,0	116	2	7	60,95
25,00	7,0	121	2	9	66,76
31,50	9,0	124	2	9	91,30
40,00	12,5	150	3	11	167,08
50,00	16,0	153	3	13	199,73
63,00	20,0	185	4	15	305,76
80,00	25,0	196	4	17	472,55
100,00	22,0	230	4	3	1.489,03

					AV18
D1 mm	D mín. mm	L1 mm	CM	Z	HSS €
16,00	3,2	93	1	7	53,10
20,00	4,0	116	2	7	62,11
25,00	7,0	121	2	9	68,10
31,50	9,0	124	2	9	93,15
40,00	12,5	150	3	11	170,47
50,00	16,0	153	3	13	203,67
63,00	20,0	185	4	15	292,41
80,00	25,0	196	4	17	482,04
100,00	22,0	190	4	20	1.299,39

					AV24
D1 mm	D mín. mm	L1 mm	CM	Z	HSS €
16,00	3,2	93	1	7	53,06
20,00	4,0	116	2	7	62,11
25,00	7,0	121	2	9	71,33
31,50	9,0	124	2	9	93,05
40,00	12,5	150	3	11	148,16
50,00	16,0	153	3	13	191,37
63,00	20,0	185	4	15	311,58
80,00	25,0	196	4	17	481,55
100,00	27,0	210	4	3	1.263,84

AVELLANADORES DE 1 CANAL

1Z

MANGO CILÍNDRICO

Ref. AV27

HSS



Ref. AV29

HSS

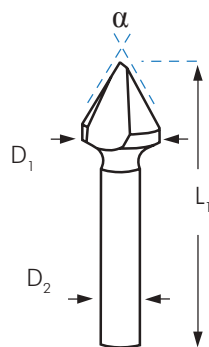

				AV27		AV29
	D ₁ mm	D ₂ mm	L ₁ mm	€		€
AV270600	6,0	6,0	45	11,24	AV290600	20,74
AV270800	8,0	8,0	50	11,87	AV290800	21,72
AV271000	10,0	8,0	50	12,58	AV291000	22,74
AV271200	12,0	8,0	50	14,65	AV291200	25,55
AV271600	16,0	10,0	56	17,62	AV291600	31,11
AV272000	20,0	10,0	60	25,04	AV292000	39,98
AV272500	25,0	12,0	75	32,98	AV292500	62,96
AV273000	30,0	12,0	80	47,57	AV293000	82,22
AV274000	40,0	13,0	89	118,06	AV294000	142,92
AV275000	50,0	13,0	98	145,76	AV295000	213,52

1Z

MANGO CÓNICO

Ref. AV34

HSS



Ref. AV28

HSS

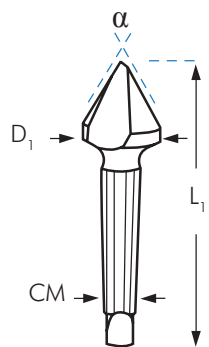

				AV34		AV28
	D ₁ mm	CM	L ₁ mm	€		€
AV341600	16,0	1	92	54,06	AV281600	51,72
AV342000	20,0	2	107	67,74	AV282000	56,66
AV342500	25,0	2	110	87,24	AV282500	84,00
AV343000	30,0	2	114	99,14	AV283000	110,70
AV344000	40,0	3	145	159,51	AV284000	145,75
AV345000	50,0	3	152	232,91	AV285000	221,34

AVELLANADORES PARA ASIENTOS DE TORNILLOS «ALLEN»

MANGO CILÍNDRICO

DIN
373
HSS

Ref. AV2

NOTA: La longitud de corte se entiende sin la guía.

* El ajuste grueso se utiliza para avellanar agujeros roscados.

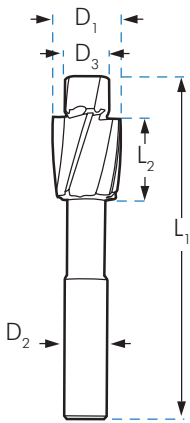

AJUSTE					AV2		AV2M		AV2G				
	D1 mm	D2 mm	L1 mm	L2 mm	D3 mm	FINO €	D3 mm	MEDIO €	D3 mm	AGUJERO ROSCADO €			
M3	6,0	5,0	71	14	AV2M3	3,2	18,67	AV2MM3	3,4	18,67	AV2GM3	2,5	18,67
M4	8,0	5,0	71	14	AV2M4	4,3	18,67	AV2MM4	4,5	18,67	AV2GM4	3,3	18,67
M5	10,0	8,0	80	18	AV2M5	5,3	18,67	AV2MM5	5,5	18,67	AV2GM5	4,2	18,67
M6	11,0	8,0	80	18	AV2M6	6,4	21,04	AV2MM6	6,6	21,04	AV2GM6	5,0	21,04
M7	20,0	12,7	90	20	AV2M7	7,4	38,85						
M8	15,0	12,5	100	22	AV2M8	8,4	26,08	AV2MM8	9,0	26,08	AV2GM8	6,8	26,08
M9	22,0	16,0	100	22	AV2M9	9,4	38,85						
M10	18,0	12,5	100	22	AV2M10	10,5	31,05	AV2MM10	11,0	31,05	AV2GM10	8,5	31,05
M11	22,0	18,8	100	22	AV2M11	11,5	41,33						
M12	20,0	12,5	100	22	AV2M12	13,0	36,22	AV2MM12	14,0	36,22	AV2GM12	10,2	36,22
M14	24,0	12,5	100	22	AV2M14	15,0	56,66	AV2MM14	15,5	56,66	AV2GM14	12,0	56,66
M16	26,0	12,5	100	22	AV2M16	17,0	62,32	AV2MM16	17,5	62,32	AV2GM16	14,0	62,32

CABEZA CÓNICA CON GUÍA

DIN
1866
HSS

Ref. AV3

NOTA: La longitud de corte se entiende sin la guía.

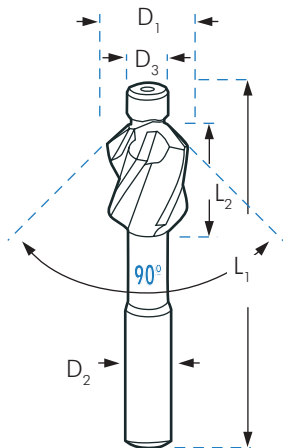

AJUSTE							AV3	
	D1 mm	D2 mm	L1 mm	L2 mm	D3 mm	FINO €		
M3	6,3	6,0	71	14,0	AV3M3	3,2	27,22	
M4	8,3	8,0	71	14,0	AV3M4	4,3	27,22	
M5	10,4	10,0	80	18,0	AV3M5	5,3	27,22	
M6	12,4	10,0	80	18,0	AV3M6	6,4	30,94	
M8	16,5	12,0	100	22,0	AV3M8	8,4	37,86	
M10	20,5	12,0	100	22,0	AV3M10	10,5	40,96	
M12	24,5	13,0	110	25,0	AV3M12	13,0	49,92	

AVELLANADORES PARA ASIENTOS DE TORNILLOS «ALLEN»

MANGO CÓNICO



Ref. AV5

NOTA: La longitud de corte se entiende sin la guía.
* El ajuste grueso se utiliza para avellanar agujeros roscados.

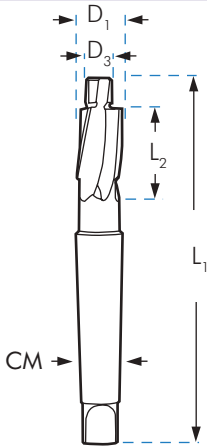

AJUSTE					AV5		AV5M		AV5G				
	D1 mm	CM	L1 mm	L2 mm	D3 mm	FINO	D3 mm	MEDIO	D3 mm	AGUJERO ROSCADO			
						€		€		€			
M8	15,0	2	132	22	AV5M8	8,4	51,96	AV5MM8	9,0	51,96	AV5GM8	6,8	51,96
M10	18,0	2	140	25	AV5M10	10,5	53,33	AV5MM10	11,0	53,33	AV5GM10	8,5	53,33
M12	20,0	2	140	25	AV5M12	13,0	59,00	AV5MM12	14,0	59,00	AV5GM12	10,2	59,00
M14	24,0	2	150	30	AV5M14	15,0	81,90	AV5MM14	15,5	81,90	AV5GM14	12,0	81,90
M16	26,0	3	180	35	AV5M16	17,0	96,17	AV5MM16	17,5	96,17	AV5GM16	14,0	96,17
M18	30,0	3	180	35	AV5M18	19,0	103,77	AV5MM18	20,0	103,77	AV5GM18	15,5	103,77
M20	33,0	3	190	40	AV5M20	21,0	113,06	AV5MM20	22,0	113,06	AV5GM20	17,5	113,06
M22	36,0	3	190	40	AV5M22	23,0	137,78	AV5MM22	24,0	137,78	AV5GM22	19,5	137,78
M24	40,0	3	190	40	AV5M24	25,0	166,56	AV5MM24	26,0	166,56	AV5GM24	21,0	166,56
M27	46,0	4	255	50	AV5M27	30,0	189,26						
M30	48,0	4	255	50	AV5M30	33,0	228,95						

APLICACIONES DE LOS TIPOS DE AJUSTES: FINO, MEDIO Y AGUJERO ROSCADO

T1 : Tornillos Cabeza Cilíndrica DIN 84 y DIN 7984
Tornillos Autorroscantes DIN 7513
DIN 7500

T2 : Tornillos Cabeza Cilíndrica DIN 6912
T3 : Tornillos Cabeza Cilíndrica DIN 912

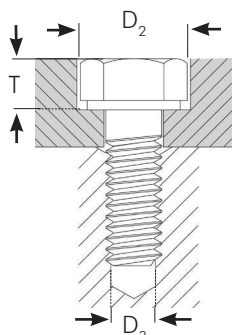

	FINO	MEDIO	AGUJERO ROSCADO				
ROSCAS MÉTRICAS	D3 mm	D3 mm	D3 mm	D2 mm	T1 mm	T2 mm	T3 mm
M3	3,2	3,4	2,5	6,0	2,4	--	3,4
M4	4,3	4,5	3,3	8,0	3,2	3,4	4,6
M5	5,3	5,5	4,2	10,0	4,0	4,2	5,7
M6	6,4	6,6	5,0	11,0	4,7	4,8	6,8
M8	8,4	9,0	6,8	15,0	6,0	6,0	6,0
M10	10,5	11,0	8,5	18,0	7,0	7,5	11,0
M12	13,0	13,5	10,2	20,0	8,0	8,5	13,0
M14	15,0	15,5	12,0	24,0	9,0	9,5	15,0
M16	17,0	17,5	14,0	26,0	10,5	11,5	17,5
M18	19,0	20,0	15,5	30,0	11,5	12,5	19,5
M20	21,0	22,0	17,5	33,0	12,5	13,5	21,5
M22	23,0	24,0	19,5	36,0	13,5	14,5	23,5

AVELLANADORES CON ELEMENTOS INTERCAMBIABLES PARA ASIENTOS DE TORNILLOS CON CABEZA "ALLEN" Y CÓNICA



EL SISTEMA BLUEMASTER

El sistema BLUEMASTER es único para operaciones de cajado y avellanado, ayudándole a incrementar su productividad y disminuir sus costes.

Nuestros portaherramientas, fresas, brocas y guías pueden combinarse para adaptarlos a todo tipo de máquinas y aplicaciones.

Usted puede componer fácilmente más de 1.500.000 de herramientas especiales con sólo 1.300 piezas.

El sistema consta de 3 grupos de dimensiones: SERIE A, SERIE B y SERIE C.

Todas las combinaciones tienen que hacerse con elementos que pertenezcan al mismo grupo. Herramientas de distintos grupos no son combinables entre sí.

En las siguientes páginas encontrará tanto los rangos de medidas disponibles en cada grupo, así como recomendaciones para la correcta elección tanto de la herramienta como de los datos de corte.

Importante!

* Usando corte de metal duro colocar el tornillo de ajuste axial en contacto con la guía o broca insertada.

* Dejar un espacio entre el filo y la guía o broca para prevenir roturas por impacto accidental.

* El tornillo axial también se usa para prolongar la vida de las brocas tras reafiladas.

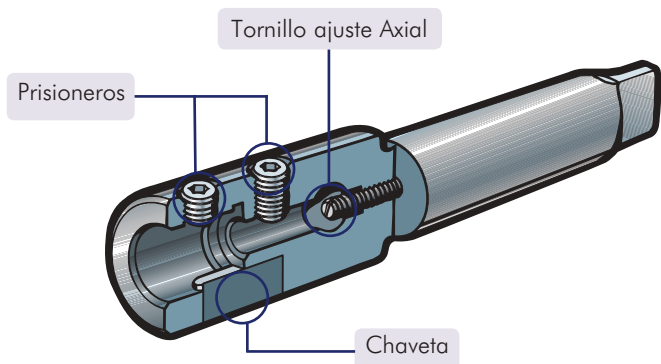

DIMENSIONES DE GUÍA, PORTA Y BROCA

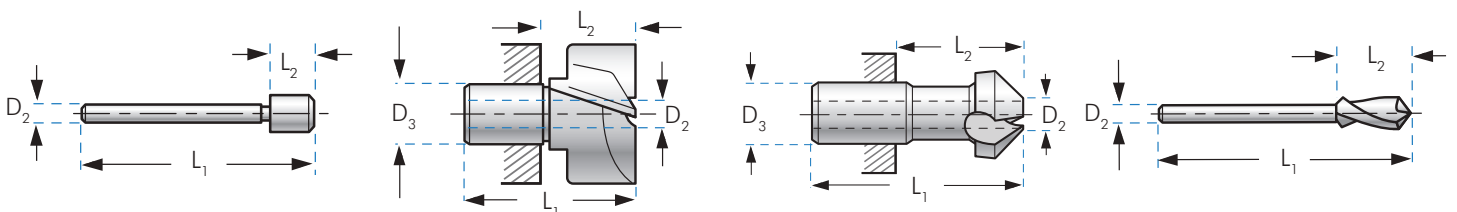

GUÍA

	D ₂ mm	L ₁ mm	L ₂ mm
--	----------------------	----------------------	----------------------

AGP	4	64	9
BGP	6	80	14
CGP	10	110	20

PORTAS

	D ₃ mm	D ₂ mm	L ₁ mm	L ₂ mm
--	----------------------	----------------------	----------------------	----------------------

APAV-MD-PQ	10	4	40	22
BPAV-MD-PQ	14	6	48	28
CPAV-MD-PQ	22	10	61	33

AVELLANADOR

	D ₃ mm	D ₂ mm	L ₁ mm	L ₂ mm
--	----------------------	----------------------	----------------------	----------------------

AVC	10	4	40	22
BVC	14	6	48	28
CVC	22	10	61	33

BROCA

	D ₂ mm	L ₁ mm	L ₂ mm
--	----------------------	----------------------	----------------------

ABP	4	70	15
BBP	6	95	25
CBP	10	125	30

AVELLANADORES CON ELEMENTOS INTERCAMBIABLES PARA ASIENTOS DE TORNILLOS CON CABEZA "ALLEN" Y CÓNICA

SERIE A

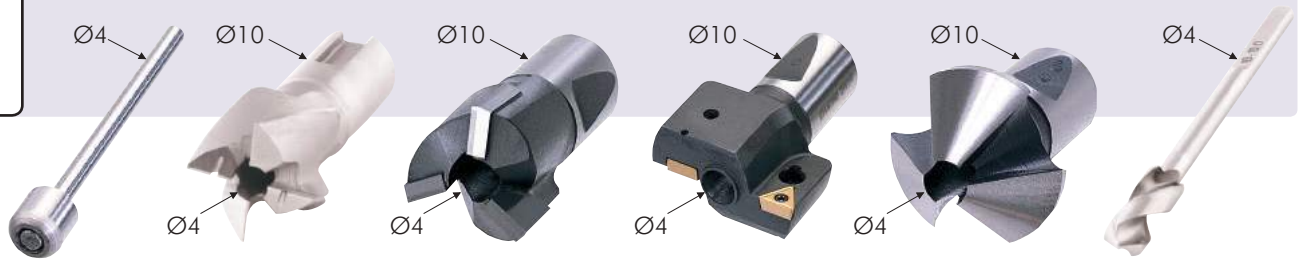

GUÍA		PORTA		PORTA		PLAQUITA INTERCAMBIABLE		AVELLANADOR		BROCA		
AGP	APAV	APAVMD	APAVPQ	AVC	ABP							
	HSS	MD	Plaquita no incluida	90° HSS	HSS							
€	€	€	€	€	€							
					ABP0430					54,02		
					ABP0450					54,02		
					ABP0500					54,02		
					ABP0530					54,02		
					ABP0550					54,02		
					ABP0600			AVC0800	123,98	63,49		
					ABP0640					63,49		
					ABP0650			AVC1000	123,98	63,49		
AGP0400	31,17											
AGP0450	37,17	APAV0700	95,13									
AGP0550	37,17	APAV0800	93,97									
AGP0600	37,17	APAV0900	93,97									
AGP0650	37,17	APAV1000	90,97	APAVMD1000	267,16							
AGP0640	37,17											
AGP0660	37,17	APAV1100	93,97	APAVMD1100	267,16			AVC1200	125,83	63,49		
AGP0500	37,17											
		APAV1150	103,91								ABP0700	63,49
		APAV1200	95,13	APAVMD1200	267,16			AVC1150	121,68			
		APAV1250	105,52					AVC1240	127,29			
		APAV1300	103,68	APAVMD1300	267,16							
		APAV1350	119,37					AVC1350	127,29			
		APAV1400	103,68	APAVMD1400	269,69			AVC1400	136,46			
		APAV1450	119,61									
AGP0840	37,64											
AGP0900	37,64	APAV1500	104,83	APAVMD1500	272,69			AVC1500	137,60			
AGP0680	37,17											
AGP0700	37,17	APAV1600	110,82	APAVMD1600	278,93			AVC1600	138,30			
AGP0750	37,17	APAV1700	112,93	APAVMD1700	284,94			AVC1650	134,62			
AGP0800	37,64	APAV1800	115,90	APAVMD1800	290,92	APAVPQ1800	607,71					
AGP0850	37,64	APAV1900	123,31	APAVMD1900	304,09							
AGP0900	37,64	APAV2000	127,69	APAVMD2000	310,56	APAVPQ2000	681,15					
AGP0950	37,64	APAV2100	139,24	APAVMD2100	325,32							
AGP1000	37,64											
AGP1050	37,64											
AGP1100	37,64											
AGP1150	37,64											

ADAPTADORES



						APH
	D1	D2	L1	L2	CM	€
	mm	mm	mm	mm	Ømm	
APHCM1	18	10	110	48	CM1	222,81
APHCM2	18	10	132	57	CM2	218,66
APH-10	18	10	92	42	Ø10	208,26

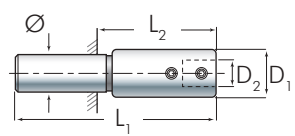
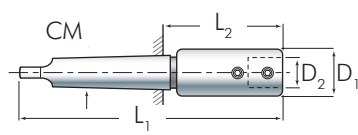

PLAQUITAS DE REPUESTO

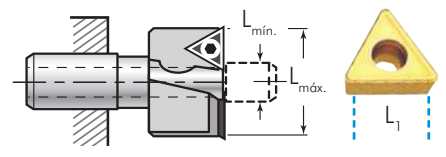

				PPQ
	L1	Lmin.	Lmax.	€
	mm	mm	Ømm	
PPQ07	7	18	20	23,09

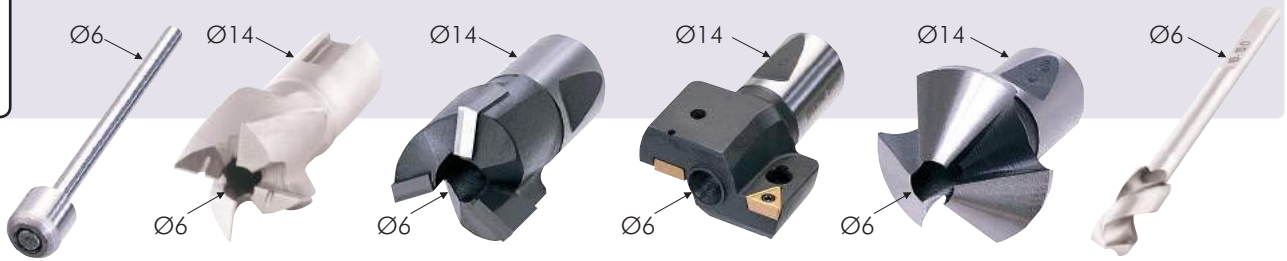
**AVELLANADORES CON ELEMENTOS INTERCAMBIABLES PARA
 ASIENTOS DE TORNILLOS CON CABEZA "ALLEN" Y CÓNICA**
**SERIE
 B**

GUÍA

PORTA

PORTA

PLAQUITA
INTERCAMBIABLE

AVELLANADOR

BROCA

BGP		BPAV		BPAVMD		BPAVPQ		BVC		BBP	
€		HSS €		MD €		Plaquita no incluida PMD €		90° HSS €		HSS €	
		BPAV1300	105,29	BPAVMD1300	284,94						
		BPAV1350	118,90								
		BPAV1400	105,29	BPAVMD1400	284,94						
		BPAV1450	118,90								BBP0800 75,51
BGP0840	35,10										
BGP0900	35,10	BPAV1500	105,29	BPAVMD1500	284,94			BVC15	130,69	BBP0900	75,51
BGP0680	35,10										
BGP0800	35,10										
BGP1000	35,10	BPAV1550	120,53								
BGP1150	37,17	BPAV1600	111,07	BPAVMD1600	295,54					BBP0840	75,51
BGP1250	38,56	BPAV1650	128,83							BBP0850	75,51
BGP1350	42,48	BPAV1700	115,67	BPAVMD1700	295,54					BBP0950	75,51
BGP1450	42,94	BPAV1750	129,75							BBP1000	86,12
		BPAV1900	133,46	BPAVMD1900	298,10					BBP1050	86,12
BGP1050	37,17										
BGP1100	37,17	BPAV1800	120,07	BPAVMD1800	298,10			BVC20	147,77	BBP1100	86,12
BGP0850	35,10										
BGP1300	42,48										
BGP1400	42,94	BPAV2000	133,46	BPAVMD2000	307,33	BPAVPQ2000	608,22	BVC25	153,79		
BGP1020	37,17										
BGP1500	42,94										
BGP1550	42,94	BPAV2400	157,71	BPAVMD2400	326,50	BPAVPQ2400	609,01	BVC28	178,94		
BGP1200	37,17										
BGP1700	42,94										
BGP1750	42,94	BPAV2600	168,55	BPAVMD2600	328,34	BPAVPQ2600	698,27	BVC30	182,88		
BGP1400	42,94										
BGP1900	43,86										
BGP2000	54,72	BPAV3000	227,66	BPAVMD3000	358,13	BPAVPQ3000	698,27				
BGP1550	42,94										
		BPAV3400	269,22	BPAVMD3400	413,05	BPAVPQ3400	805,96				
BGP1750	42,94										

ADAPTADORES



						BPH
	D ₁ mm	D ₂ mm	L ₁ mm	L ₂ mm	CM Ømm	€
BPHCM1	24	14	123	62	CM1	247,07
BPHCM2	24	14	137	62	CM2	225,59
BPHCM3	24	14	160	66	CM3	247,07
BPH-12	24	14	120	55	Ø12	223,04

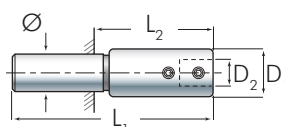
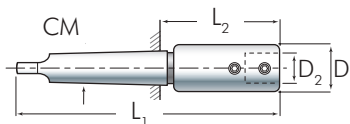

PLAQUITAS DE REPUESTO

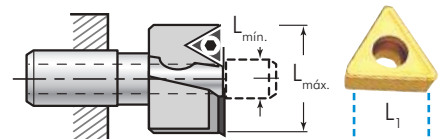

				PPQ
	L ₁ mm	L _{min.} mm	L _{máx.} Ømm	€
PPQ07	7	20	25	23,09
PPQ10	10	26	33	20,79
PPQ12	12	34	36	20,79

AVELLANADORES CON ELEMENTOS INTERCAMBIABLES PARA ASIENTOS DE TORNILLOS CON CABEZA "ALLEN" Y CÓNICA

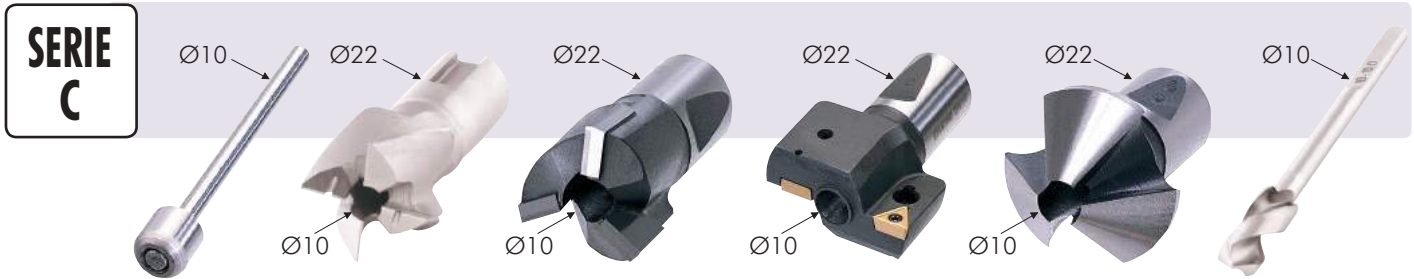

GUÍA		PORTA		PORTA		PLAQUITA INTERCAMBIABLE		AVELLANADOR		BROCA	
CGP		CPAV		CPAVMD		CPAVPQ		CVC		CBP	
€		HSS €		MD €		Plaquita no incluida PMD €		90° HSS €		HSS €	
CGP1200	39,94	CPAV2300	191,18	CPAVMD2300	356,27						
CGP1250	39,94	CPAV2400	193,71	CPAVMD2400	352,57						
CGP1300	39,94	CPAV2500	209,43	CPAVMD2500	353,27						
CGP1350	39,94	CPAV2600	213,58	CPAVMD2600	362,97						
CGP1400	46,88	CPAV2700	216,58								
CGP1450	46,88	CPAV2800	220,74	CPAVMD2800	366,43					CBP1700	188,65
CGP1500	46,88	CPAV2900	226,04							CBP1800	212,65
CGP1600	46,88	CPAV3100	245,68							CBP1900	223,04
CGP1650	46,88	CPAV3200	253,76	CPAVMD3200	400,14					CBP2100	241,76
CGP1700	46,88	CPAV3300	256,06							CBP2300	290,92
CGP1900	46,88										
CGP2000	46,88	CPAV3000	229,04	CPAVMD3000	404,07			CVC35	266,68	CBP2000	241,76
CGP1550	46,88										
CGP2100	52,19										
CGP2200	52,19	CPAV3400	258,62	CPAVMD3400	429,47	CPAVPQ3400	833,46	CVC37	282,16	CBP2200	269,69
CGP1750	46,88										
CGP1850	46,88	CPAV3500	270,85								
CGP2300	52,19										
CGP2400	52,19	CPAV3600	274,08	CPAVMD3600	441,24	CPAVPQ3600	833,46	CVC37	282,16	CBP2400	297,18
CGP1950	46,88										
CGP2500	52,19										
CGP2600	64,18	CPAV4000	318,18	CPAVMD4000	488,80	CPAVPQ4000	852,66	CVC40	299,94		
CGP2100	52,19										
CGP2200	52,19	CPAV4500	392,53			CPAVPQ4500	868,23				
CGP2050	52,19	CPAV5000	570,09			CPAVPQ5000	1.015,88				
		CPAV5500	600,56			CPAVPQ5500	1.199,85				
		CPAV6000	632,88			CPAVPQ6000	1.199,85				
		CPAV6500	711,86			CPAVPQ6500	1.372,14				

ADAPTADORES



						CPH
	D ₁ mm	D ₂ mm	L ₁ mm	L ₂ mm	CM Ømm	€
CPHCM2	36	22	160	85	CM2	325,32
CPHCM3	36	22	180	87	CM3	307,33
CPHCM4	36	22	206	89	CM4	344,50
CPHCM5	36	22	240	91	CM5	758,04
CPH-12	36	22	140	71	Ø20	223,04

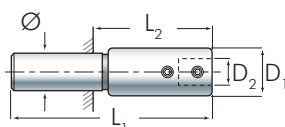
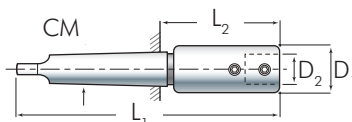

PLAQUITAS DE REPUESTO

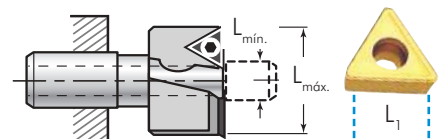

				PPQ
	L ₁ mm	L _{min.} mm	L _{max.} Ømm	€
PPQ12	12	34	45	20,79
PPQ17	17	<46		32,21

ESTUCHES METÁLICOS DE AVELLANADORES
ESTUCHES DE BROCAS AVELLANADORAS PARA TUBO Y CHAPA HSS y HSSCo

Avellanadores

Rosa

HSS

(Brocas Ref. AV30)



REFERENCIA	AV30BM012
Nº BROCAS	3
CALIDAD	HSS
CONTENIDO	AV30BM0 - AV30BM1 - AV30BM2 (3-14mm) (6-20mm) (16-30mm)
P.V.P. €	HSS 93,40
€	HSS TiN 185,85

HSSCo

(Brocas Ref. AVC30)



REFERENCIA	AVC30BM012
Nº BROCAS	3
CALIDAD	HSSCo
CONTENIDO	AVC30BM0 - AVC30BM1 - AVC30BM2 (3-14mm) (6-20mm) (16-30mm)
P.V.P. €	HSSCo 135,82
€	HSSCo TiN 200,62

ESTUCHES DE BROCAS ESCALONADAS CON CANALES RECTOS HSS y HSSCo
HSS
HSSCo

(Brocas Ref. AV40)

REFERENCIA	AV40BM234	AV40BM22122
Nº BROCAS	3	3
CONTENIDO	AV40BM2 - AV40BM3 - AV40BM4 (4-12mm) (4-20mm) (4-30mm)	AV40BM2 - AV40BM21 - AV40BM22 (4-12mm) (7+10-20mm) (10+20-30mm)
P.V.P. €	HSS 180,59	227,57
€	HSS TiN 272,07	345,79
P.V.P. €	HSSCo 233,82	
€	HSSCo TiN 338,49	



Ref. AV40BM234

ESTUCHE DE BROCAS ESCALONADAS HELICOIDALES HSS
HSS

(Brocas Ref. AV42)

REFERENCIA	AV42BM234
Nº BROCAS	3
CALIDAD	HSS
CONTENIDO	AV42BM2 - AV42BM3 - AV42BM4
P.V.P. €	HSS 254,42
€	HSS TiN 334,32



Ref. AV42BM234

ESTUCHES METÁLICOS DE AVELLANADORES



(Avellanadores Ref. AV6)

REFERENCIA	AV6CM1	AV6CM2	AV6CM3
Nº BROCAS	6	6	7
CONTENIDO	Ø 6-8-10-11,5-15-19 mm	Ø 6,3-8,3-10,4-12,4-16,5-20,5 mm	Ø 6,3-8,3-10,4-12,4-16,5- 20,5-25 mm
P.V.P. €	124,12	120,18	182,99



(Avellanadores Ref. AV7)

REFERENCIA	AV7CM1	AV7CM2	AV7CM3
Nº BROCAS	6	6	7
CONTENIDO	Ø 6-8-10-11,5-15-19 mm	Ø 6,3-8,3-10,4-12,4-16,5-20,5 mm	Ø 6,3-8,3-10,4-12,4-16,5- 20,5-25 mm
P.V.P. €	139,28	142,89	213,18



(Avellanadores Ref. AV16)

REFERENCIA	AV16CM1	AV16CM2	AV16CM3
Nº BROCAS	6	6	7
CONTENIDO	Ø 6-8-10-11,5-15-19 mm	Ø 6,3-8,3-10,4-12,4-16,5-20,5 mm	Ø 6,3-8,3-10,4-12,4-16,5- 20,5-25 mm
P.V.P. €	230,96	235,78	329,08



(Avellanadores Ref. AV8)

REFERENCIA	AV8CM2	AV8CM3
Nº BROCAS	6	7
CONTENIDO	Ø 6,3-8-10-12,5-16-20 mm	Ø 6,3-8-10-12,5-16-20-25 mm
P.V.P. €	172,39	222,87



(Avellanadores Ref. AV9)

REFERENCIA	AV9CM1	AV9CM5
Nº BROCAS	6	7
CONTENIDO	Ø 6,3-8,3-10,4-12,4-16,5-20,5 mm	Ø 6,3-8,3-10,4-12,4-16,5-20,5-25 mm
P.V.P. €	176,31	228,17



Ref. AV6CM2



(Avellanadores Ref. AV10)

REFERENCIA	AV10CM1	AV10CM6
Nº BROCAS	6	7
CONTENIDO	Ø 6,3-8,3-10,4-12,4-16,5-20,5 mm	Ø 6,3-8,3-10,4-12,4-16,5-20,5-25 mm
P.V.P. €	198,36	245,54

* Otros estuches bajo demanda AV19, etc.

ESTUCHES METÁLICOS DE AVELLANADORES
ESTUCHES DE AVELLANADORES PARA DESBARBAR CON AGUJERO DE 90° HSS Y HSSCo

(Avellanadores Ref. AV1)

REFERENCIA	AV1S1	AV1S2
Nº BROCAS	4	5
CONTENIDO	Ø 10 - 14 - 20 - 27 mm	Ø 10 - 14 - 20 - 27 - 30 mm
P.V.P. €	HSS 146,80	249,47
€	HSS TiN 225,98	356,45



(Avellanadores Ref. AV20)

REFERENCIA	AV2S1	AV2S2
Nº BROCAS	4	5
CONTENIDO	Ø 10 - 14 - 20 - 27 mm	Ø 10 - 14 - 20 - 27 - 30 mm
P.V.P. €	HSSCo 189,84	314,00
€	HSSCo TiN 275,50	439,61



Ref. AV1S1

ESTUCHES DE AVELLANADORES PARA ASIENTOS DE TORNILLOS "ALLEN" AJUSTE FINO, MEDIO Y AGUJERO ROSCADO

(Avellanadores Ref. AV2)

REFERENCIA	AV2M3-10	AV2M3-12
Nº BROCAS	6	7
CONTENIDO	M3 - M4 - M5 - M6 - M8 - M10	M3 - M4 - M5 - M6 - M8 - M10 - M12
P.V.P. €	138,33	177,65



(Avellanadores Ref. AV2M)

REFERENCIA	AV2M3-10M	AV2M3-12M
Nº BROCAS	6	7
CONTENIDO	M3 - M4 - M5 - M6 - M8 - M10	M3 - M4 - M5 - M6 - M8 - M10 - M12
P.V.P. €	138,33	177,65



(Avellanadores Ref. AV2G)

REFERENCIA	AV2M3-10G	AV2M3-12G
Nº BROCAS	6	7
CONTENIDO	M3 - M4 - M5 - M6 - M8 - M10	M3 - M4 - M5 - M6 - M8 - M10 - M12
P.V.P. €	138,33	177,65



Ref. AV2M3-10

REBARBADORES DE PRECIÓN

LOS REBARBADORES BLUEMASTER

Los rebarbadores BLUEMASTER se emplean para eliminar las virutas acumuladas en bordes y aristas de piezas fabricadas en metal, plástico o madera.

El mango puede ser utilizado con todos los grupos de cuchillas, intercambiando oportunamente el portacuchillas para cada uno de ellos.

El sistema se completa ensamblando los tres componentes señalados:

CUCHILLA + PORTACUCHILLAS + MANGO UNIVERSAL

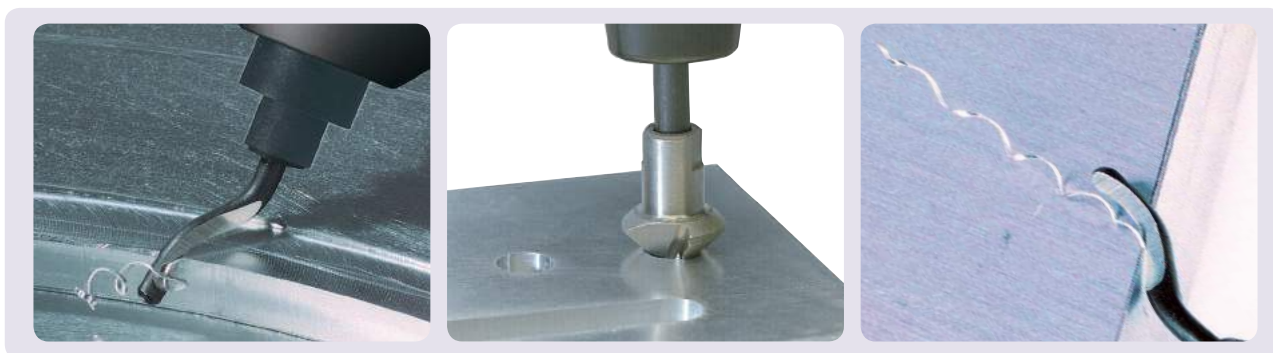
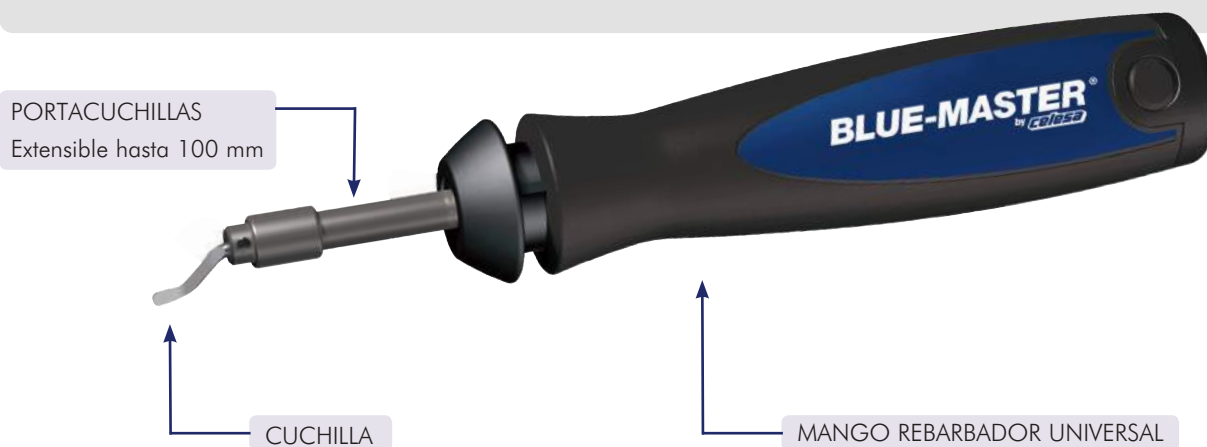

MANGO REBARBADOR UNIVERSAL

Usos generales.

Válido para portacuchillas:

Ref. RBB / RBC / RBD / RBE / RBF



RBB1

Blister 1 ud.: 12,12 €

REBARBADORES DE PRECISIÓN
**GRUPO
B**
PORTACUCHILLAS GRUPO B

Para cuchillas rebarbadoras Grupo B

RBB

9,23 €

CUCHILLAS GRUPO B

 Cuchilla rebarbadora
 Serie corta: acero, aluminio, plástico

RB10*

Blister 10 ud.: 1,62 €/Ud

 Cuchilla rebarbadora Bidireccional
 Serie corta: latón, fundición

RB20

Blister 10 ud.: 1,62 €/Ud

 Cuchilla rebarbadora doble arista
 agujeros de 4 mm de profundidad

RB30

Blister 10 ud.: 1,62 €/Ud



Cuchilla punzonadora de Metal Duro

RB50*

Blister 1 ud.: 28,93 €

 Cuchilla rebarbadora
 para parte posterior de un taladro
 de hasta 20 mm de profundidad

RB60*

Blister 10 ud.: 3,36 €/Ud

 Cuchilla
 rebarbadora de aristas exteriores

RB70MD*

Blister 1 ud.: 34,55 €

*Hasta fin de existencia

**GRUPO
C**
PORTACUCHILLAS GRUPO C

Para cuchillas rebarbadoras Grupo C

RBC

Blister 1 ud.: 9,23 €

CUCHILLAS GRUPO C

Cuchilla rasqueta ancho 4 x 20 mm

RC40*

Blister 1 ud.: 18,81 €



Cuchilla rasqueta ancho 8 x 30 mm

RC42*

Blister 1 ud.: 23,40 €

*Hasta fin de existencia

**GRUPO
D**
PORTACUCHILLAS GRUPO D

Para cuchillas rebarbadoras Grupo D

RBD

Blister 1 ud.: 9,23 €

CUCHILLAS GRUPO D

 Cuchilla rebarbadora de metal duro
 en "V" Hembra cantos hasta 3 mm

RD80MD*

Blister 1 ud.: 49,17 €

 Cuchilla rebarbadora de Metal Duro
 en "V" Hembra cantos hasta 8 mm

RD82MD*

Blister 1 ud.: 77,09 €

*Hasta fin de existencia

REBARBADORES DE PRECIÓN



GRUPO E

PORTACUCHILLAS GRUPO E



RBE
Blister 1 ud.: 9,23 €

Para cuchillas rebarbadoras Grupo E

CUCHILLAS GRUPO E



Cuchilla rebarbadora para interiores y exteriores
Serie larga: acero, aluminio, plástico

RE10
Blister 10 ud.: 1,99 €/Ud



Cuchilla rebarbadora para cantos rectos: chaveteros,...

RE35
Blister 10 ud.: 2,13 €/Ud



Cuchilla rebarbadora bidireccional
Serie larga: latón, fundición

RE20
Blister 10 ud.: 1,99 €/Ud



Cuchilla rebarbadora cerrada doble arista para agujeros de 4 mm de profundidad

RE30
Blister 10 ud.: 1,99 €/Ud



Cuchilla rebarbadora para la parte posterior de un taladro de hasta 20 mm de profundidad

RE60*
Blister 5 ud.: 2,79 €/Ud

*Hasta fin de existencia

GRUPO F

PORTACUCHILLAS GRUPO F



RBF
Blister 1 ud.: 9,23 €

Para cuchillas rebarbadoras Grupo F

CUCHILLAS GRUPO F (Rosca M05 x 0,80)



Cuchilla avellanadora HSS Ø 12 mm

RF12
Blister 1 ud.: 20,76 €



Cuchilla avellanadora HSS Ø 30 mm

RF30
Blister 1 ud.: 69,36 €



Cuchilla avellanadora HSS Ø 20 mm

RF20
Blister 1 ud.: 40,12 €

REBARBADORES DE PRECISIÓN
CONJUNTO B
JRB1

Contenido B:

Ref. RB10



Ref. RBB1



Ref. RB20



Ref. RBB



Blister: 26,29 €

CONJUNTO C
JRB2

Contenido C:

Ref. RC42

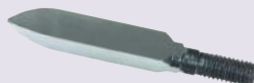

Ref. RBB1



Ref. RBC



Blister: 47,88 €

CONJUNTO D
JRB3

Contenido D:

Ref. RD80MD



Ref. RBB1



Ref. RBD

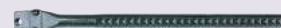

Blister: 75,47 €

CONJUNTO E
JRB4

Contenido E:

Ref. RE10



Ref. RBB1



Ref. RE20



Ref. RBB1



Ref. RE30



Ref. RBE

Blister: 29,28 €

